

TELEPHONES

Art. 924

Standard doorphone in ABS plastic case colour white, with 12Vac buzzer, door opening button , input for an electronic call tone, condenser microphone.

Wall mounting by two expansion type screws or directly to standard round type Ø 60MM embedding box or standard rectangular (American type) embedding box. Desk mounting by means of the Desk Kit Art. 938.

Terminals: Screw and nut type.

Connecting terminals:

- 1 Microphone
- 2 Receiver (earphone)
- 3 Ground
- 4 Input electronic tone
- 5 Door opener
- 6 Buzzer 12Vac

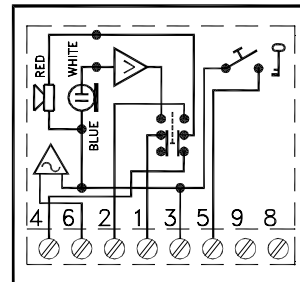
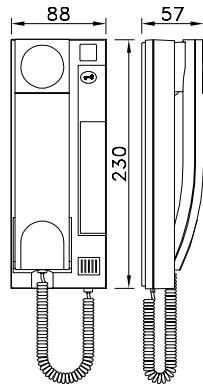

Art. 924

Morsettiera

- 1 Microfono
- 2 Auricolare
- 3 Massa
- 4 Ingres. chiam. elettron.
- 5 Apriporta
- 6 Ronzatore 12Vac

Art. 926

doorphone as Art. 924 but with service button 

Connecting terminals:

- 1 Microphone
- 2 Receiver (earphone)
- 3 Ground
- 4 Input electronic tone
- 5 Door opener
- 6 Buzzer 12Vac
- 8 } service button
- 9 } button

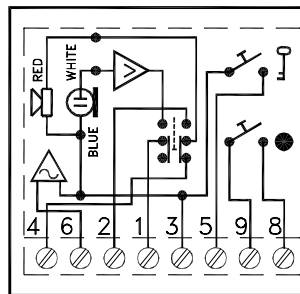
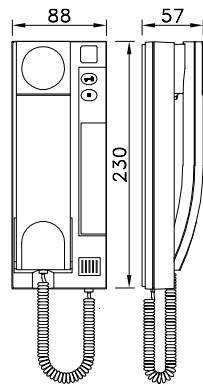

Art. 926

Art. 926

citofono come articolo precedente ma con pulsante di servizio 

Morsettiera

- 1 Microfono
- 2 Auricolare
- 3 Massa
- 4 Ingres. chiam. elettron.
- 5 Apriporta
- 6 Ronzatore 12Vac
- 8 } Pulsante di servizio
- 9 } Servizio

Art. 924S

As Art. 924 but incorporating privacy of speech and lock opening.

Art. 926S

Doorphone as Art. 924S but with service button 

Art. 924MS

As Art. 924 but with call tone ON-OFF switch.

Art. 924S

Citofono come Art. 924 ma per impianti con segreto di conversazione. Possibilità di selezionare due livelli del segnale di chiamata.

Art. 926S

Citofono come articolo precedente ma con pulsante di servizio 

Art. 924MS

Citofono come Art. 924S ma con in più un tasto per disattivare il segnale di chiamata.

Art. 925

Doorphone for 1+1 systems. Electronic tone only.

Art. 925S

As Art. 925 but incorporating full lock and speech privacy.

Connecting terminals:

- 1 Speech, call, lock command.
- 3 Common.

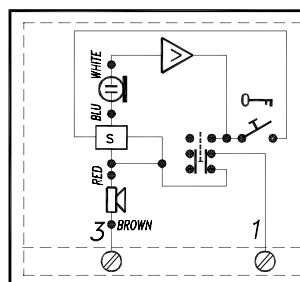
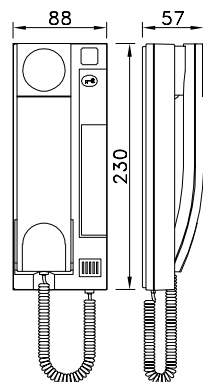

Art. 925 - 925S

Art. 925

Citofono per impianti 1+1. Chiamata elettronica.

Art. 925S

Citofono come Articolo precedente ma con segreto di conversazione e di apertura serratura elettrica.

Morsettiera

- 1 Fonia, chiamata, comando serratura
- 3 Comune

Art. SMART 1

Standard doorphone in ABS plastic case colour white, 12 Vac buzzer, door opening button, predisposed for electronic call, condenser microphone. Wall mounting by two expansion type screws. Screw terminals.

Connecting terminals:

- 1 Microphone
- 2 Receiver (earphone)
- 3-7 Ground
- 4 Input electronic call
- 5 Door opener
- 6 12 Vac Buzzer

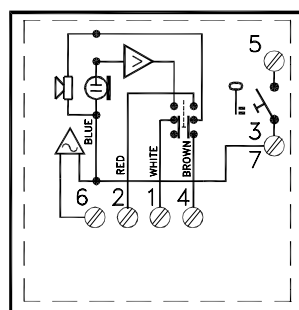
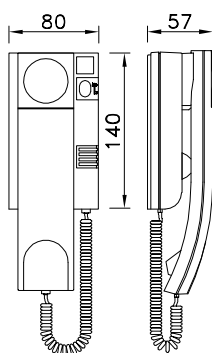
Art. SMART 1
Art. SMART 1

Citofono in plastica ABS colore bianco, ronzatore 12Vac, pulsante apriporta, predisposto per chiamata elettronica, microfono a condensatore. Da installare a muro mediante due viti e relativi tasselli ad espansione. morsetti serrafilo a vite.

Morsettiera

- 1 Microfono
- 2 Auricolare
- 3-7 Massa
- 4 Ingres. chiamata elettr.
- 5 Apriporta
- 6 Ronzatore 13Vac.

Art. SMART 2

Doorphone as Art. Smart 1 but with service button.

Connecting Terminals

- 1 Microphone
- "
- "
- 8 } service button
- 9 }

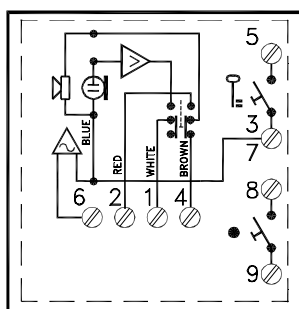
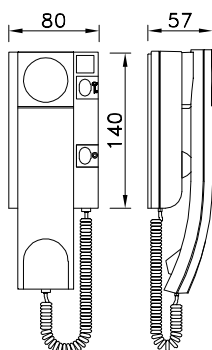
Art. SMART 2
Art. SMART 2

Citofono come articolo precedente ma con pulsante di servizio.

Morsettiera

- 1 Microfono
- "
- "
- 8 } pulsante di servizio
- 9 }

INTERCOMS WITH SELECTION PUSH BUTTONS
Art. 928-5

Intercom set in ABS plastic case colour white, with one door opening button, and 4 push buttons for internal communication plus outside station if required, condenser microphone, electronic tone for internal calls. Wall mounting by two expansion type screws. Desk mounting by means of the Desk Kit Art. 938.

Connecting terminals:

- A Microphone
- B Receiver (earphone)
- X Input electronic call
- Ground
- T Common push buttons
- P Door opening button. Or call buton.

- 1 } Call push buttons
- 2 }
- 3 }
- 4 }

- R } Terminals for buzzer Art. RZ/102
- } necessary in case of call from the outdoor station

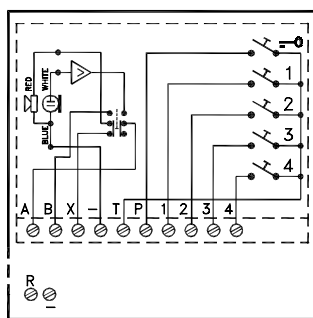
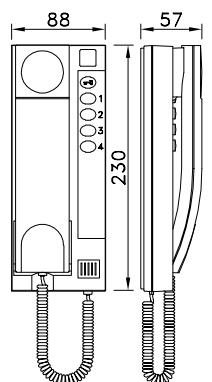
Art. 928-5
INTERCOMUNICANTI
Art. 928-5

Intercomunicante con 1 pulsante apriporta e 4 pulsanti di chiamata, in plastica ABS colore bianco, chiamate interne con nota elettronica modulata, microfono a condensatore. Da installare a filo muro mediante due viti e relativi tasselli ad espansione o da tavolo utilizzando la base zavorrante Art. 938.

Morsettiera

- A Microfono
 - B Auricolare.
 - X Ingres. chiam. elettr.
 - Massa.
 - T Comune pulsanti.
 - P Pulsante apriporta o di chiamata
- 1 } Pulsanti di chiamata
 - 2 }
 - 3 }
 - 4 }
- R } Ronzatore RZ/102 per eventuale
 - } chiamata dal posto esterno

Art. 928-10

Intercom set as Art. 928-10 with door opening button and 9 push buttons.

Connecting terminals:

- A Microphone
- "
- "
- 7 } Call push buttons
- 8 }
- 9 }

- R } Terminals for buzzer Art. RZ/102
- } necessary in case of call from the outdoor station

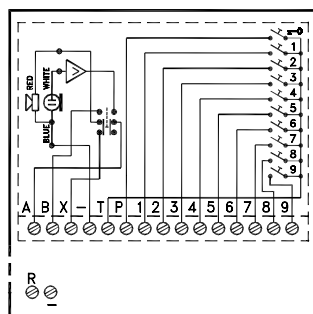
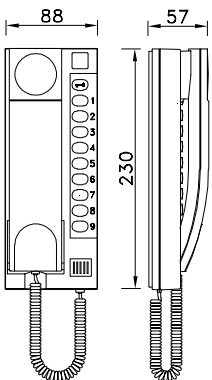
Art. 928-10
Art. 928-10

Intercomunicante con 1 pulsante apriporta e 9 pulsanti di chiamata. Stesse caratteristiche articolo precedente.

Morsettiera

- A Microfono.
 - "
 - "
 - 7 } Pulsanti di chiamata
 - 8 }
 - 9 }
- R } Ronzatore RZ/102 per eventuale
 - } chiamata dal posto esterno